

PATENT ABSTRACTS OF JAPAN

(11)Publication number : 2001-101190

(43)Date of publication of application : 13.04.2001

(51)Int.Cl. G06F 17/30
 G06F 3/00
 G06F 13/00
 H04L 12/18
 H04N 5/445

(21)Application number : 11-255520

(71)Applicant : JISEDAI JOHO HOSO SYSTEM
 KENKYUSHO:KK
 SONY CORP

(22)Date of filing : 09.09.1999

(72)Inventor : GONNO YOSHIHISA
 NISHIO IKUHIKO
 HARAOKA KAZUO
 TAKABAYASHI KAZUHIKO
 YAMAGISHI YASUAKI

(30)Priority

Priority number : 11215128 Priority date : 29.07.1999 Priority country : JP

(54) DEVICE AND METHOD FOR RECEPTION

(57)Abstract:

PROBLEM TO BE SOLVED: To improve operability in the case of displaying a plurality of contents.
SOLUTION: Contents #1 are displayed on a master screen (display window A), and contents #2 are selectively displayed on its slave screen (display window B). The contents #1 and #2 are contents of different broadcasting channels that are temporally distributed at the same time. The contents #2 are divided into segments S001, S002, S003, ..., S007. Meta-data is also attached to a segment corresponding to a characteristic scene of the contents #2. Meanwhile, profile information proper to a user is set. Meta-data coinciding with the set user profile information is selected, and because a segment identifier is attached to the selected meta-data, the segment having the segment identifier is displayed on the window B. When the segment is no longer broadcasted, the window B disappears, and an image of the window A is reproduced on the entire display screen 415.

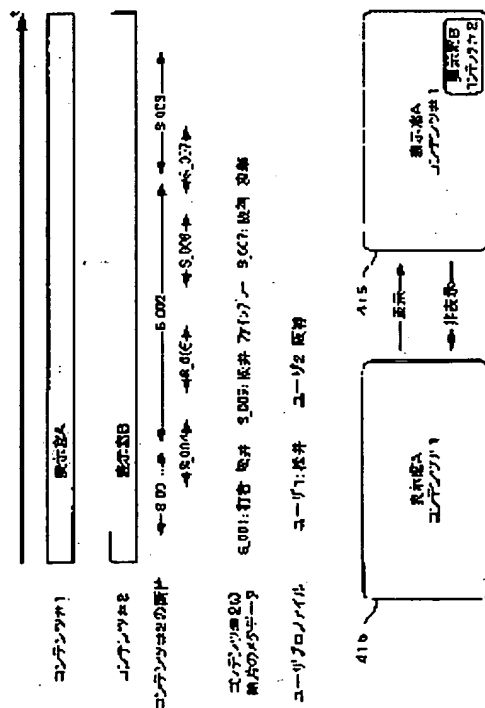

LEGAL STATUS

[Date of request for examination]

14.03.2006

[Date of sending the examiner's decision of rejection]

BEST AVAILABLE COPY

[Kind of final disposal of application other than the examiner's decision of rejection or application converted registration]

[Date of final disposal for application]

[Patent number]

[Date of registration]

[Number of appeal against examiner's decision of rejection]

[Date of requesting appeal against examiner's decision of rejection]

[Date of extinction of right]

*** NOTICES ***

JPO and NCIP are not responsible for any damages caused by the use of this translation.

1. This document has been translated by computer. So the translation may not reflect the original precisely.
2. **** shows the word which can not be translated.
3. In the drawings, any words are not translated.

CLAIMS

[Claim(s)]

[Claim 1] The receiving set characterized by consisting of a user profile set up in the receiving set for showing the contents which consist of continuous data by user profile actuation means to operate a user profile, and the user profile actuation means, and a means to add to the image which is indicating by current, or to transpose to it based on the received metadata, and to display other images.

[Claim 2] In the receiving set for showing the contents which consist of continuous data A receiving means to receive contents data, the fragmentation data about the fragment of contents, and the metadata matched with the above-mentioned fragmentation data, A user profile generation means to set up one or more user profile information, The receiving set characterized by consisting of a playback control means which displays the image of the above-mentioned fragment which collated metadata and a user profile, extracted the above-mentioned fragment corresponding to conditions, and added to the image which is indicating by current, or replaced, and was extracted.

[Claim 3] It is the receiving set which the above-mentioned fragmentation data consist of a parameter for specifying a fragment in an identifier and the above-mentioned contents in claim 2, the above-mentioned fragmentation data dissociate with the above-mentioned metadata, are transmitted, and is characterized by the above-mentioned metadata being associated by the above-mentioned fragmentation data and the identifier.

[Claim 4] It is the receiving set which the above-mentioned fragmentation data consist of a parameter for specifying a fragment in an identifier and the above-mentioned contents in claim 2, and is characterized by compounding the above-mentioned fragmentation data with the above-mentioned metadata, and transmitting them.

[Claim 5] Equipment characterized by describing the above-mentioned metadata and the above-mentioned user profile in the same format in claim 2.

[Claim 6] The receiving approach characterized by setting up a user profile with a user profile actuation means, adding or transposing it to the set-up user profile and the image which is indicating by current based on the received metadata in the reception approach for showing the contents which consist of continuous data, and displaying other images.

[Claim 7] In the receiving set for showing the contents which consist of continuous data Two or more contents data and the fragmentation data about the fragment of two or more contents, A receiving means to receive the metadata matched with the above-mentioned fragmentation data, A user profile generation means to set up one or more user profile information, The receiving set characterized by consisting of a playback control means which displays the image of the above-mentioned fragment which collated metadata and a user profile, extracted the above-mentioned fragment corresponding to conditions, and added to the image which is indicating by current, or replaced, and was extracted.

[Claim 8] In the receiving set for showing the contents which consist of continuous data Two or more contents data and the fragmentation data about the fragment of two or more contents, A receiving means to receive the metadata matched with the above-mentioned fragmentation data, A user profile generation means to set up one or more user profile information, The receiving set

characterized by consisting of a playback control means which displays the above-mentioned metadata which collated metadata and a user profile, extracted the above-mentioned metadata corresponding to conditions, and added to the image which is indicating by current, or replaced, and was extracted.

[Claim 9] The receiving set characterized by displaying the metadata about two or more above-mentioned contents on some display screens in claims 7 or 8.

[Claim 10] The receiving set characterized by the ability to display the above-mentioned metadata about two or more above-mentioned contents on coincidence in the form of an icon or a chart in claim 9.

[Claim 11] The receiving set characterized by notifying having extracted the fragment or metadata corresponding to the above-mentioned conditions in claims 7 or 8 to a user.

[Claim 12] It is the receiving set carry out being related by the above-mentioned fragmentation data and the identifier as the description while the above-mentioned fragmentation data consist of a parameter for specifying a fragment in an identifier and two or more above-mentioned contents in claims 7 or 8, the above-mentioned fragmentation data about two or more above-mentioned contents are collectively transmitted while the above-mentioned fragmentation data dissociate with the above-mentioned metadata and are transmitted, and the above-mentioned metadata is collectively transmitted about two or more above-mentioned contents.

[Claim 13] It is the receiving set which the above-mentioned fragmentation data consist of a parameter for specifying a fragment in an identifier and the above-mentioned contents in claims 7 or 8, and is characterized by compounding the above-mentioned fragmentation data with the above-mentioned metadata, and transmitting them.

[Claim 14] Equipment characterized by describing the above-mentioned metadata and the above-mentioned user profile in the same format in claims 7 or 8.

[Claim 15] In the reception approach for showing the contents which consist of continuous data The step which sets up one or more user profile information, and two or more contents data, The step which receives the fragmentation data about the fragment of two or more contents, and the metadata matched with the above-mentioned fragmentation data, The receiving approach characterized by consisting of a step which displays the image of the above-mentioned fragment which collated metadata and a user profile, extracted the above-mentioned fragment corresponding to conditions, and added to the image which is indicating by current, or replaced, and was extracted.

[Claim 16] In the reception approach for showing the contents which consist of continuous data The step which sets up one or more user profile information, and two or more contents data, The step which receives the fragmentation data about the fragment of two or more contents, and the metadata matched with the above-mentioned fragmentation data, The receiving approach characterized by consisting of a step which displays the above-mentioned metadata which collated metadata and a user profile, extracted the above-mentioned metadata corresponding to conditions, and added to the image which is indicating by current, or replaced, and was extracted.

[Translation done.]

*** NOTICES ***

JPO and NCIP are not responsible for any damages caused by the use of this translation.

1. This document has been translated by computer. So the translation may not reflect the original precisely.
2. **** shows the word which can not be translated.
3. In the drawings, any words are not translated.

DETAILED DESCRIPTION

[Detailed Description of the Invention]

[0001]

[Field of the Invention] This invention is used in the field of the distribution technique of the image voice data to many and unspecified persons like broadcast service, and from much continuation data, required partial data are chosen efficiently and it relates to the receiving set and the receiving approach for receiving, accumulating / perusing.

[0002]

[Description of the Prior Art] Much technique is proposed as a distribution system of data. For example, data distribution by WWW (World Wide Web) which used HTTP (Hyper Text Transfer Protocol) on the Internet is performed. For example, in order for required data to come to hand out of the huge data constellation in WWW (World Wide Web), use of metadata is spreading. Metadata is data which describe DS. As a system which receives data alternatively based on metadata, PICS (Platform for Internet Content Selection) and RDF (Resource Description Framework) are proposed by WWW.

[0003] Moreover, metadata, such as a program title, broadcast time of day, etc. which serve as a component of EPG (Electronic Program Guide) in digital broadcasting, is EIT (Event Information Table). It is transmitted in the form. The information on EPG is described as tables of the section format called SI (Service Information), and a receiver extracts required information from this table, and it displays it on a screen. And in the broadcast data with which the user continued, data can be chosen per program by EPG.

[0004] Very much, to many terminals, although digital broadcast is an one way, it has the description which can carry out the multiple address of a lot of data. Therefore, there is an advantage with which digital broadcast and a network are united. Specifically, metadata is increasingly added to the contents on the Internet, or the contents of digital broadcasting.

[0005] The metadata (for example, EIT) in digital broadcast and the metadata in the existing networks, such as the Internet, have the problem which does not have compatibility in a transcription. Therefore, although it is possible to use both metadata as they are, since metadata is written according to text format in the system which has developed, for example on WWW like PICS or RDF, the effectiveness of transmission is not good. Furthermore, although a receiver side requires high-speed filtering in order to receive alternatively the metadata sent through the broadcast network of a broadband, in a transcription like text format, high-speed filtering is difficult.

[0006] On the other hand, metadata, such as EIT of digital broadcasting, shall have a format original with digital broadcasting, and metadata shall be sent only in the range of the descriptor decided beforehand. That is, nothing is specified about the expression format of the approach and metadata which transmit the metadata which the conversion method for using metadata, such as EIT, by WWW is not specified, either, and has a flexible expression like PICS or RDF by the MPEG system used by digital broadcasting.

[0007] In order to solve these problems, in the patent application (Japanese Patent Application No. No. 170397 [ten to]) proposed previously, the method of changing and transmitting these to the format suitable for a digital broadcasting format is proposed. That is, he is trying for previous

application to describe the metadata based on a RDF model as a table of the section format called SI like EPG.

[0008] Furthermore, when communicating the contents on networks, such as the Internet, by digital broadcast, as compared with the contents of digital broadcast, for example, a program, the contents on a network are short data. Therefore, the metadata of a data unit shorter than the metadata of a program unit is desirable. The metadata in EIT of digital broadcasting chooses the continuation data in a program unit, and it is difficult to describe the relation between metadata about partial data, and it cannot be said to be suitable [describe the metadata about partial data, or] for transmission of the contents on a network.

[0009] Moreover, he is able to once accumulate the contents of digital broadcast, and for a user to take out contents from an are recording medium, and to reincarnate if needed. In such a case, in the metadata of a program unit, there was a problem which cannot arrange the configuration of a program according to a user's taste.

[0010] In order to solve this problem, the sending set and receiving set which can realize efficient data distribution and flexible selection reception according to a user's taste are proposed by fragmenting contents and matching metadata to the partial data of arbitration in previous application (Japanese Patent Application No. No. 23220 [11 to]). This invention performs optional reception of contents more efficiently using fragmentation of such contents.

[0011] In the existing broadcast service, by the receiving side, in order to receive a desired part efficiently, displaying two or more contents on the same screen at coincidence is performed. This is called a picture in picture (parent-and-child screen), a picture, a picture (split screen), etc. Drawing 26 shows the example of a picture in picture. Contents #1 from which the broadcast channel distributed to coincidence in time differs, and #2 are displayed on the display window A and display window B of the display screen 501 of an accepting station, respectively.

[0012]

[Problem(s) to be Solved by the Invention] The viewer itself needs to perform a display / non-display change for the display window B by which the approach of displaying two or more conventional contents on the same screen at coincidence is equivalent to a child screen. Moreover, the favorite scene needed to be awaited to try listening only the specific part of contents #2 while the viewer itself always acted as the monitor of the contents of the display window B. Therefore, if operability is bad and is not concentrating the monitor, the case where a desired scene is unreceivable will produce the conventional approach.

[0013] Therefore, the purpose of this invention is to offer the receiving set and the receiving approach of making it possible to carry out selection reception of the part of a request of the contents distributed continuously in time efficiently.

[0014]

[Means for Solving the Problem] It is the receiving set characterized by to add invention of claim 1 to a user profile actuation means operate a user profile in the receiving set for showing the contents which consist of continuous data, the user profile set up by the user profile actuation means, and the image which is indicating by current based on the received metadata in order to attain the technical problem mentioned above, or to replace, and to consist of a means display other images.

[0015] In a receiving set for invention of claim 2 to present the contents which consist of continuous data A receiving means to receive contents data, the fragmentation data about the fragment of contents, and the metadata matched with fragmentation data, A user profile generation means to set up one or more user profile information, It is the receiving set characterized by consisting of a playback control means which displays the image of the fragment which collated metadata and a user profile, extracted the fragment corresponding to conditions, and added to the image which is indicating by current, or replaced, and was extracted.

[0016] Invention of claim 6 is the receiving approach characterized by setting up a user profile with a user profile actuation means, adding or transposing it to the set-up user profile and the image which is indicating by current based on the received metadata in the reception approach [describe the contents which consist of continuous data, and displaying other images.

[0017] In a receiving set for invention of claim 7 to present the contents which consist of continuous data Two or more contents data and the fragmentation data about the fragment of two or more contents, A receiving means to receive the metadata matched with fragmentation data, A user profile generation means to set up one or more user profile information, It is the receiving set characterized by consisting of a playback control means which displays the image of the fragment which collated metadata and a user profile, extracted the fragment corresponding to conditions, and added to the image which is indicating by current, or replaced, and was extracted.

[0018] In a receiving set for invention of claim 8 to present the contents which consist of continuous data Two or more contents data and the fragmentation data about the fragment of two or more contents, A receiving means to receive the metadata matched with fragmentation data, A user profile generation means to set up one or more user profile information, It is the receiving set characterized by consisting of a playback control means which displays the metadata which collated metadata and a user profile, extracted the metadata corresponding to conditions, and added to the image which is indicating by current, or replaced, and was extracted.

[0019] In the reception approach for invention of claim 15 to present the contents which consist of continuous data The step which sets up one or more user profile information, and two or more contents data, The step which receives the fragmentation data about the fragment of two or more contents, and the metadata matched with fragmentation data, It is the receiving approach characterized by consisting of a step which displays the image of the fragment which collated metadata and a user profile, extracted the fragment corresponding to conditions, and added to the image which is indicating by current, or replaced, and was extracted.

[0020] In the reception approach for invention of claim 16 to present the contents which consist of continuous data The step which sets up one or more user profile information, and two or more contents data, The step which receives the fragmentation data about the fragment of two or more contents, and the metadata matched with fragmentation data, It is the receiving approach characterized by consisting of a step which displays the metadata which collated metadata and a user profile, extracted the metadata corresponding to conditions, and added to the image which is indicating by current, or replaced, and was extracted.

[0021] In this invention, the image of the contents with which the user set up the fragmentation information on contents based on the metadata which related with metadata, and distributed and received, and the user profile set up beforehand can be displayed. Therefore, a user does not need to change the display of an image and the monitor of the image does not have to be carried out. Operability can be improved by it. Moreover, this invention can identify the fragment of the arbitration in two or more image voice streams, and can reproduce the fragment corresponding to a user profile. Furthermore, not only the fragment of contents but metadata can be extracted, and it can reproduce.

[0022]

[Embodiment of the Invention] Hereafter, 1 operation gestalt of this invention is explained.

Drawing 1 expresses the configuration of an example of the contents distribution system which can apply this invention. Information providers 101a and 101b hold the meta-information over the meta-information schema and each contents data showing the data of the contents to offer, and the structure of the meta-information about the data in a database. As contents data, the page of WWW etc. is raised, for example. Information providers 101a and 101b are connected with a broadcasting station 102 and the accepting-station equipments 103a and 103b through the bidirectional network 105. It is supposed that an information provider 101 is able to provide the accepting-station equipments 103a and 103b with contents data, a metadata schema, and metadata through the bidirectional network 105.

[0023] The metadata to the metadata schema and each contents data with which a broadcasting station 102 also expresses the structure of the data of the contents to offer and the metadata about the data with the database is held. The program broadcast, for example is raised as contents data. A broadcasting station 102 is connected with the accepting-station equipments 103a and 103b through the multiple address network 104, and the accepting-station equipments

103a and 103b are provided with contents data, a metadata schema, and metadata through the multiple address network 104. Moreover, contents data, a metadata schema, and metadata can be received through the bidirectional network 105 from an information provider 101, and accepting-station equipment 103 can also be provided with it through the multiple address network 104. Furthermore, a metadata schema may be stored in recording media, such as CD-ROM set to the program guide, without transmitting. Thus, a metadata schema needs to be shared by a transmitting side and the receiving side.

[0024] Drawing 2 shows the example of a configuration of a broadcasting station 102. The contents with which the accepting-station equipments 103a and 103b are provided are accumulated in the contents recording section 203. The contents offered by information providers 101a and 101b may also be accumulated here temporarily. Furthermore, when sent out to contents work and coincidence like a live program, it may be only a temporary cache for monitors.

[0025] The metadata schema showing the structure of the metadata to the contents data stored in the contents recording section 203 is accumulated in the metadata schema recording section 201. The structure of the information added [guide / a "program title", a "program genre", "broadcasting hours", / a "parental guide"] is defined as a metadata schema for example, to program data. The class of metadata schema stored in the metadata schema recording section 201 is not limited to one kind, but is identified by the metadata schema identifier.

[0026] For example, if contents data are a TV program, a "program name", a "program genre", and a "parental guide" will be added, and if it is data broadcasting, a "program name", a "program genre", and "object OS classification" will be added as metadata. Thus, since the structures of the metadata added by the contents made into the object of metadata or the time also differ, two or more metadata schemas exist. It is good for a receiving set also as ready-for-sending ability in the metadata schema which furthermore expresses the structure of metadata through the bidirectional network 105 or the multiple address network 104 in advance of transmission of metadata if needed beforehand so that renewal of a metadata schema may be possible.

[0027] The contents fragmentation section 204 generates the fragmentation data for choosing a specific contents fragment out of the continuation data sent out from the contents recording section 203. This fragmentation data is sent to the fragmentation data accumulation section 211. Fragmentation data consist of a fragment identifier for identifying the specific fragment of contents uniquely, and a parameter for specifying a fragment. A fragment identifier and a parameter are accumulated in the fragmentation data accumulation section 211. This parameter is start time, duration or start time, end time, etc. of that fragment. A fragment identifier is sent to the metadata composition section 202. The metadata composition section 202 relates the metadata relevant to the specific fragment of the continuation data corresponding to a fragment identifier with fragmentation data in the format according to the structure of a metadata schema, and compounds and outputs metadata with a fragment identifier.

[0028] For example, the fragment identifier for specifying the program and fragment is outputted as metadata to a certain program or the fragment within the program. When a program is a fragment, a fragment identifier is added and outputted to metadata, such as "news at program title:7:00", and "program genre:news." In the case of the fragment within a program, a fragment identifier is added and outputted to the metadata "the genre:politics of news." Furthermore, the identifier of the metadata schema which metadata follows is also contained in these.

[0029] When these metadata composition sections 202, the contents fragmentation section 204, and the fragmentation data accumulation section 211 function synthetically, metadata generation equipment 215 is constituted.

[0030] The metadata schema transducer 205 changes into a transmission format the metadata schema accumulated in the metadata schema recording section 201. Although the symbolic conventions of the schema accumulated in the metadata schema recording section 201 may differ for every object contents data and every information provider, the metadata schema transducer 205 transforms the format of a metadata schema into one transmission format.

Various things can be used as a transmission format in this case. As an example, data can be transmitted in the section format of an MPEG system. Other metadata and fragmentation data can also be transmitted in the same format.

[0031] The metadata transducer 206 changes into a transmission format the metadata with a fragment identifier generated in the metadata composition section 202. Although the symbolic conventions of the metadata compounded in the metadata composition section 202 may differ for every object contents data and every information provider, the metadata transducer 206 transforms the format of metadata into one transmission format.

[0032] The contents transducer 207 changes into a transmission format the contents which consist of continuation data. The fragmentation data-conversion section 212 changes into a transmission format the fragmentation data stored in the fragmentation data accumulation section 211. Although symbolic conventions may differ for every object contents data and every information provider, the fragmentation data-conversion section 212 transforms the format of fragmentation data into one transmission format. Various things can be used as a transmission format in this case. As an example, data can be transmitted in the section format of an MPEG system.

[0033] And the metadata schema transmission-control section 208, the metadata transmission-control section 209, the contents transmission-control section 210, and the fragmentation data transmission-control section 213 supply the metadata schema changed into each transmission format, metadata with a fragment identifier, contents, and fragmentation data to the signal transmitting section.

[0034] In the case of the multiple address network 104, as a transmission line, MPEG-2 system and broadcast by an IP multicast etc. are assumed here, and, in the case of a network 105, it is IP (Internet Protocol) bidirectionally. The circuit by ATM (Asynchronous Transfer Mode) etc. is assumed.

[0035] Although omitted in drawing 2, the communications control section connected with the bidirectional network 105 is prepared. The communications control section receives the demand of the metadata schema from the accepting-station equipments 103a and 103b, metadata, and contents data, takes out the metadata schema, metadata, and contents data which were demanded, and makes it possible to transmit to the accepting-station equipments 103a and 103b. In addition, information providers 101a and 101b take the same configuration as a broadcasting station 102 except not having the transmission part which performs transmission to the multiple address network 104 in drawing 2.

[0036] In addition, with 1 operation gestalt and other operation gestalten mentioned later, a metadata schema, metadata, and fragmentation data are transmitted previously in time than contents. In the case where contents are sport relay broadcast programs, the thing small, if possible of the time delay which contents have is desirable.

[0037] The example of a configuration of accepting-station equipment is shown in drawing 3. The metadata schema reception-control section 301, the metadata reception-control section 302, the contents reception-control section 303, and the fragmentation data reception-control section 316 receive the metadata schema transmitted through networks 104 or 105, respectively, metadata with a fragment identifier, fragmentation data, and contents from a signal receive section. In this case, each data is separated in a signal receive section.

[0038] The received metadata schema is supplied to the metadata schema restoration section 304. The metadata schema restoration section 304 restores the received metadata schema to the format which is easy to use within a terminal. The restored metadata schema is accumulated in the metadata schema are recording section 305. In addition, a metadata schema can also be acquired by are recording media, such as CD-ROM which is not based on the communication link through the multiple address network 104 or the bidirectional network 105, for example, is distributed with a program guide etc.

[0039] The received metadata with a fragment identifier is supplied to the metadata restoration section 306. The metadata restoration section 306 restores the received metadata with a fragment identifier to the format which is easy to use within a terminal. The restored metadata with a fragment identifier is accumulated in the metadata are recording section 307.

[0040] The received contents are supplied to the contents restoration section 308. The contents restoration section 308 restores the received contents data to the format which is easy to use within a terminal. The restored contents data are stored in the contents recording section 309 via contents playback / are recording control section 313.

[0041] The received fragmentation data are supplied to the fragmentation data restoration section 317. The fragmentation data restoration section 317 restores the received fragmentation data to the format which is easy to use within a terminal. The restored fragmentation data are stored in the fragmentation data accumulation section 318.

[0042] The user of accepting-station equipment lets the user profile control unit 310 pass, generates the user profile information on a user proper with reference to the metadata schema memorized by the metadata schema recording section 305, and accumulates in the user profile recording section 311. As an example, user profile information is the user taste information reflecting a user's taste. As user profile information, other things (resolution etc.), for example, the capacity of a receiver, may be used. The generated user profile information is described based on metadata and a common metadata schema.

[0043] By referring to the metadata schema accumulated in the metadata schema recording section 305, the user profile information accumulated in the user profile recording section 311, and the fragmentation data stored in the fragmentation data accumulation section 318 in the metadata analysis section 312 The information for only the metadata suitable for both conditions being chosen from the metadata accumulated in the metadata recording section 307, and choosing the fragment relevant to the selected metadata is generated with reference to fragmentation data.

[0044] The information generated in the metadata analysis section 312 is supplied to contents playback / are recording control section 313. Contents playback / are recording control section 313 reconfigures the fragment of continuation data, and presents contents in the data display section 315. On the other hand, the metadata display-control section 314 controls the display of the metadata in the data display section 315. In addition, by preparing the communications control section which is not illustrated, a metadata schema, metadata, fragmentation data, and contents mind the bidirectional network 105, and can also be required and received.

[0045] It is necessary to receive the contents of two channels (service) to coincidence with this 1 operation gestalt. The input section 316 for specifying the channel which should be received in the contents reception-control section 303 is formed, and assignment of two channels received by the input section 316 is made. Moreover, the input section 316 is used also in order to specify what should be reproduced in the contents accumulated in contents playback / are recording control section 313.

[0046] In the system of MPEG 2, as shown in drawing 4 , Time Division Multiplexing of two or more kinds of TS packets is carried out to one transport stream (it abbreviates to TS). TS packet is made into the length of 188 bytes, and TS header is added to the head. In TS header, the packet identifier (it abbreviates to PID) is contained. The packet corresponding to the contents which receive with reference to this PID is separated. The packet of two separated contents is restored in the contents restoration section 308 (decode). Two contents are supplied to contents playback / are recording control section 313.

[0047] One operation gestalt of this invention mentioned above is explained further. Drawing 5 explains metadata and fragmentation data and the data with which the program of Service ID=Svc#1 is continuing [the channel identifier] in time are illustrated as an example. In the case of digital broadcast, the identifier of a program unit, Event ID=E#5 [for example,], is given. Such continuation data are fragmented by eight fragments. Fragment identifier Segment ID=S#1, S#2, and are added to each fragment.

[0048] And in addition to the fragment identifier Segment ID mentioned above, each fragment can specify the fragment of the arbitration in continuation data with the fragmentation data which consist of a parameter, for example, the start time (start time) and duration (duration) of the fragment, as shown in drawing 6 . Such time amount is time amount specified in the stream of MPEG-2. Moreover, fragmentation data and metadata are described by RDF/XML used by WWW

[0049] Drawing 7 shows the example of a metadata schema. For example, when genres are news, as the category, synthesis, society, politics, economy, and a sport are specified and domestic and overseas are specified as an area. In this case, fragmentation data shall be shown in drawing 8. That is, fragmentation data consist of the fragment identifier (S#3, S#5, ...) and parameter (start time and duration) for every fragment. Moreover, drawing 9 shows an example of the metadata corresponding to a metadata schema as shown in drawing 7. Fragmentation data and a common fragment identifier are added and transmitted also to metadata. Therefore, fragmentation data and metadata can be linked by the fragment identifier.

[0050] In addition, although fragmentation data are transmitted as a stream different from metadata, it compounds with metadata and you may make it transmit metadata with fragmentation data in 1 operation gestalt of this invention mentioned above.

[0051] Furthermore, 1 operation gestalt of this invention is explained to a detail. The accepting-station equipment of this 1 operation gestalt displays automatically only the scene corresponding to the conditions of the user profile which the viewer created beforehand on the display screen of the data display section 315 on a screen. Drawing 10 shows such actuation roughly. For example, two display windows A and B are set up by the method of a picture in picture.

[0052] It is made as [display / contents #2 / display main contents #1 on the display window A equivalent to the parent screen of the display screen 415 of the data display section 315, and / on the display window B equivalent to the child screen / alternatively]. Contents #1 and #2 are contents from which the broadcast channel distributed to coincidence in time differs. For example, contents #1 is drama broadcast and contents #2 are baseball relay broadcast.

[0053] Contents #2 are fragments S001, S002, and S003, ..., S007. It is divided. Moreover, metadata is given about the fragment corresponding to the characteristic scene of contents #2. For example, fragment S001 It corresponds, the metadata of "batter Matsui" exists, and it is a fragment S005. It corresponds, the metadata of the "Matsui fine play" exists, and it is a fragment S007. It corresponds and the metadata of the "Hanshin attack" exists.

[0054] On the other hand, it is generated by the user profile control unit 310, and the profile information of the user proper of "user 1:Matsui" and "user 2:Hanshin" is accumulated in the user profile are recording section 311. User profile information is created by starting the application for a user profile setup. For example, a user profile setting screen is displayed on the screen of the data display section 315 (or other display devices), it displays that it is also with a pull down menu about the list of values of an attribute ID and each attribute ID in the screen, and a setup of a user profile of a user is alternatively enabled by a setup and it in the attribute ID and value of the request in a list. In this case, specification of the channel which it is going to display on a display window B (child screen), and a program is also made.

[0055] The metadata analysis section 312 chooses the metadata which agrees with the set-up user profile information from the metadata are recording section 307. Since the fragment identifier is attached to the selected metadata, the fragment chosen based on the fragmentation data which fragmentation data with the fragment identifier were chosen from the fragmentation data accumulation sections 318, and chose is displayed on a display window B. for example, the inside of contents #2 -- fragment S001 metadata -- user profile information -- " -- since it agrees in user 1:Matsui" -- a display window B -- generating -- fragment S001 An image is displayed on a display window B. This fragment S001 If broadcast no longer, a display window B will disappear and the image of a display window A (contents #1) will be reproduced by the display screen 415 whole. Thus, when the fragment corresponding to the set-up user profile information is broadcast, a child screen is automatically expressed as 1 operation gestalt of this invention.

[0056] Furthermore, 1 operation gestalt of this invention is explained more to a detail. Drawing 11 is an example of a symbolic convention about metadata and user profile information. The example shown in drawing 11 shows the RDF schema for baseball game description. This schema is a kind of template, Team in drawing 11, BaseballGame, Event, Status, etc. are the attributes ID equivalent to a metadata schema, and the value (it is equivalent to metadata) is specified with regards to the attribute ID. Such a symbolic convention is beforehand distributed among a receiving side by transmission or media, and is shared between the sending set and the receiving

set.

[0057] Drawing 12 indicates the example of the metadata for every fragment to be the user profile set up based on the symbolic convention shown in drawing 11. The user profile information on user profile ID=P#1 is the taste information on the scene of a fine play. The user profile information on user profile ID=P#2 is the taste information on a scene that Nomo took the strikeout. On the other hand, a fragment identifier and metadata exist to each fragment.

[0058] Even when baseball broadcast is relay broadcast, on real time, metadata can be created in a transmitting side (broadcasting station), and it can transmit. The existing relay broadcast is also inputted into real time by people, and the display of the judgment result of a ball/strike, the display of an out count, etc. are broadcast. Therefore, it is possible by preparing the suitable tool for a metadata input to create metadata as shown in drawing 12 about an on-the-spot program also by relay broadcast by the broadcasting station side.

[0059] At the example of drawing 12, it is fragment identifier Segment ID=S#12. The user profile information and the conditions of user profile ID=P#1 have agreed [metadata], and the user profile information and the conditions of user profile ID=P#2 have agreed [the metadata of fragment identifier Segment ID=S#5]. Therefore, when the scene to which these fragment identifiers were given while he was watching a certain program by the display window A is broadcast, a display window B is displayed automatically and the scene corresponding to these fragment identifiers is displayed on a display window B.

[0060] Drawing 13 and drawing 14 show the flow of the screen-display control thread in 1 operation gestalt. This display control is realized by the software which runs by the background in a receiver. As shown in drawing 13, in the condition (step S1) of the waiting for metadata reception, reception of metadata judges agreement / un-agreeing in step S2 (step S3). [of conditions] It is the processing made by the metadata analysis section 2. When metadata is received on a display screen, you may make it display several second room [about] time amount and a banner, in order to make it possible to recognize easily that the viewer received metadata, since metadata is transmitted and is not always received. Agreement / un-agreeing are processings which detect agreement between a user profile and the metadata which received, as explained with reference to drawing 12. [of conditions]

[0061] In step S3, if un-agreeing is detected, the display of a fragment will be unnecessary and processing will be completed. If agreement is detected at step S3, the same fragmentation data as the fragment identifier of the metadata which agreed will be read from the fragmentation data accumulation section 307, and will be memorized (step S4).

[0062] Next, as shown in drawing 14, the memorized fragmentation data are analyzed (step S11). That is, the start time and duration of a fragment with which conditions agreed are investigated, and the fragment which corresponds based on the result is received and restored (step S12). The restored fragment may be stored in the contents are recording section 309. Next, a display window B is generated (step S13). And the fragment applicable to a display window B is displayed (step S14). A display of duration and an applicable fragment eliminates a display window B (step S15).

[0063] Next, other operation gestalten of this invention are explained. Drawing 15 shows the configuration of the program manufacture sending set of other operation gestalten, for example, a broadcasting station. The same reference mark is given to the broadcasting station (refer to drawing 2) of 1 operation gestalt, and a corresponding part, and the explanation is omitted. With other operation gestalten, two or more metadata and fragmentation data to an image voice stream are generated to coincidence.

[0064] For this reason, Plurality 215a, 215b, 215c, and 215d, for example, four metadata generation equipments, is connected in juxtaposition to the contents are recording section 203. As explained with reference to drawing 2, each metadata generation equipment is constituted when the metadata composition section 202, the contents fragmentation section 204, and the fragmentation data accumulation section 211 function synthetically. Therefore, each metadata generation equipment generates metadata, fragmentation data, and a contents fragment to coincidence about each of four image voice streams.

[0065] The metadata which the metadata generation equipments 215a-215d output, respectively

is brought together in the metadata transducer 216, and the original stream is fair and it is changed into a transmission format. Moreover, the fragmentation data which the metadata generation equipments 215a-215d output, respectively are brought together in the fragmentation data-conversion section 222, and the original stream is fair and they are changed into a transmission format. The metadata of the transmission format containing the metadata of four streams from the metadata transducer 216 is supplied to the metadata transmission-control section 219. The fragmentation data of the transmission format containing the fragmentation data of four streams from the fragmentation data-conversion section 212 are supplied to the fragmentation data transmission-control section 223.

[0066] The fragment of contents is supplied to the contents transducers 207a-207d for every stream, and each contents transducers [207a-207d] output is further supplied to the contents transmission-control sections 210a-210d.

[0067] And the metadata schema transmission-control section 208, the metadata transmission-control section 219, the contents transmission-control sections 210a-210d, and the fragmentation data transmission-control section 223 supply the metadata schema changed into each transmission format, metadata with a fragment identifier, contents, and fragmentation data to the signal transmitting section.

[0068] Thus, with other operation gestalten, sending-out processing of four image voice streams can be performed to coincidence in parallel to sending-out processing of a metadata schema, metadata, and fragmentation data. Four image voice streams can be set for example, in a plural junction program.

[0069] Drawing 16 shows the example of a configuration of the accepting-station equipment of other operation gestalten of this invention. The same reference mark is attached and shown in the accepting-station equipment in 1 operation gestalt mentioned above with reference to drawing 3 , and a corresponding part, and explanation of the part is omitted into them.

[0070] The metadata schema reception-control section 301, the metadata reception-control section 322, the contents reception-control sections 303a-303d, and the fragmentation data reception-control section 336 receive the metadata schema transmitted through networks 104 or 105, respectively, metadata with a fragment identifier, fragmentation data, and contents from a signal receive section. In this case, each data is separated in a signal receive section.

[0071] The received metadata with a fragment identifier contains the metadata with a fragment identifier of four streams. It is restored to the format which this metadata is supplied to the metadata restoration section 326, and the received metadata with a fragment identifier tends to use within a terminal. The restored metadata with a fragment identifier is accumulated in the metadata are recording section 327.

[0072] The contents of each received stream are supplied to the contents reception-control sections 303a-303d, the contents of each stream are supplied to the contents restoration sections 308a-308d, respectively, and the contents data of each received stream are restored to the format which is easy to use within a terminal. The restored contents data are stored in the contents are recording section 309 via contents playback / are recording control section 313.

[0073] The received fragmentation data contain the fragmentation data of four streams. Fragmentation data are supplied to the fragmentation data restoration section 337, and the received fragmentation data are restored to the format which is easy to use within a terminal. The restored fragmentation data are stored in the fragmentation data accumulation section 338.

[0074] The user of accepting-station equipment lets the user profile control unit 310 pass, generates the user profile information on a user proper with reference to the metadata schema memorized by the metadata schema are recording section 305, and accumulates in the user profile are recording section 311. As an example, user profile information is the user taste information reflecting a user's taste. As user profile information, other things (resolution etc.), for example, the capacity of a receiver, may be used. The generated user profile information is described based on metadata and a common metadata schema.

[0075] In the metadata analysis section 332, only the metadata suitable for both conditions is chosen from the metadata accumulated in the metadata are recording section 327 by referring to the metadata schema accumulated in the metadata schema are recording section 305, the

user profile information accumulated in the user profile are recording section 311, and the fragmentation data stored in the fragmentation data accumulation section 338.

[0076] Based on the fragment identifier which accompanies the metadata chosen in the metadata analysis section 332, and the fragmentation data obtained from the fragmentation data accumulation section 338, contents playback / are recording control section 333 receives the corresponding contents fragment alternatively. Therefore, it controls and contents playback / are recording control section 333 receives the corresponding contents reception-control sections [303a-303d] fragment. In not displaying immediately, it accumulates the received contents fragment in the contents are recording section 329. Therefore, it is also made possible to obtain the corresponding fragment by searching the contents are recording section 329.

[0077] Furthermore, contents playback / are recording control section 333 reconfigurates the corresponding fragment, and presents it in the data display section 315. On the other hand, the metadata display-control section 314 controls the display of the metadata in the data display section 315. In addition, by preparing the communications control section which is not illustrated, a metadata schema, metadata, fragmentation data, and contents mind the bidirectional network 105, and can also be required and received.

[0078] Moreover, by a viewer's direct control, playback/are recording control unit 347 is formed in order to choose contents playback / are recording control section 333 and the metadata display-control section 314.

[0079] In other operation gestalten mentioned above, it is possible to perform reception are recording processing of four image voice streams to coincidence in parallel to reception are recording processing of a metadata schema, metadata, and fragmentation information. The plural junction program of the Olympic Games is made into an example, and other operation gestalten are explained more to a detail.

[0080] Drawing 17 is an example of a data forwarding schedule. Drawing 17 A shows the schedule of four image voice streams broadcast by the plural relay broadcasts of the Olympic Games, respectively. Service (it corresponds to a channel) of each image voice stream is expressed with service ID:Svc#1, service ID:Svc#2, service ID:Svc#3, and service ID:Svc#4. The broadcast schedule of various ball game items is mapped on four image voice streams shown in drawing 17 A. The blank part into which junction has broken off in each image voice stream is a period when commercials are broadcast.

[0081] In parallel to four image voice streams, the information for identifying each broadcasting-hours frame and channel of an item by the fragment identifier is flowing as a stream (drawing 17 B) of fragmentation data. Moreover, as shown in drawing 17 C, the metadata with a fragment identifier corresponding to each fragment is flowing as a metadata stream. Furthermore, as shown in drawing 17 D, the metadata schema for interpreting the metadata of various eyes is flowing as a metadata schema stream. Thus, metadata and fragmentation data are specified by the fragment identifier to which metadata is added, and a fragment is specified with a relating eclipse and fragmentation data (a fragmentation identifier and parameter). As shown in drawing 17 A, drawing 17 B, and drawing 17 C, the metadata and fragmentation data for specifying the fragment of an image voice stream precede in time to an image voice stream.

[0082] Drawing 18 shows the example of the metadata schema for the Olympic Games. Each event is classified into a tree structure.

[0083] Drawing 19 shows the example which described a part of metadata schema of drawing 18 by XML. It is possible to describe the structure of any events by XML.

[0084] Drawing 20 shows the user profile set up based on the structure of a metadata schema. A user can set up a favorite event classification as a user profile out of a metadata schema by operating the user profile control unit 310 of an accepting station. In drawing 20, as a frame surrounds and shows, "marathon", "rhythmic gymnastics", "singles", and "****" are set up as a user profile.

[0085] Thus, as shown in drawing 21, XML can describe the set-up user profile (taste information). It is an identifier (User Profile ID) also to a user profile. It is added.

[0086] Drawing 22 shows the example of description of the metadata matched by the fragment identifier (segment ID) to each fragment. Each fragment is a fragment identifier (Segment

IDREF). It is identified and is described regardless of an actual broadcasting-hours frame and an actual channel.

[0087] Drawing 23 shows the example of description of fragmentation data. Each fragmentation data consists of a fragment identifier (Segment ID) and a parameter (Service ID, start time, end time). The fragment identifier and the fragment identifier of fragmentation data which are attached to metadata correspond, and information required in order to acquire the actual fragment corresponding to the fragment identifier currently referred to by drawing 22 is described by fragmentation data.

[0088] Metadata and fragmentation data are also described by the format of XML. Thus, a favorite fragment can be chosen, it can acquire and in the form of XML can describe all information required in order to show.

[0089] Drawing 24 is a flow chart which shows the processing for receiving and displaying the fragment corresponding to a user profile in other operation gestalten. The processing which receives the fragment corresponding to a user profile alternatively as an example, and displays the received fragment on the child screen of the data display section 315 automatically is made.

[0090] First, if processing is started, it will be in the condition of the waiting for reception of metadata (step S21). Metadata is received for every description to the fragment shown by the fragment identifier (step S22).

[0091] Comparison collating of the received metadata is carried out with the user profile set up beforehand, and it is determined whether have agreed on conditions (step S23). If it has not agreed on conditions, the metadata is canceled and processing is completed. If metadata has agreed on conditions, fragmentation data will be analyzed from the fragment identifier which accompanies the metadata, and the information about a channel, time amount, etc. for acquiring the fragment will be acquired (step S24). The directions for receiving the fragment from the acquired information are given to the contents reception-control sections 303a-303d, and it stands by until a fragment is actually received (step S25).

[0092] At step S26, a fragment is received based on the given directions. If reception of the corresponding fragment is started, a user will be notified of viewing and listening of a fragment being possible by the icon on a screen etc. (step S27). A notice may use not only a display but voice, a beep sound, etc.

[0093] Furthermore, if reception of the corresponding fragment is started, in order to make it possible to use the fragment later, it is supposed that the fragment is able to be accumulated in the contents are recording section 329. Step S28 is a step which determines whether accumulate the received fragment. For example, it sets up whether a user accumulates a fragment beforehand and it is determined whether accumulate a fragment according to the setup.

[0094] When a setup of a user is what accumulates a fragment, a fragment is accumulated to the contents are recording section 329 (step S29). Fragmentation data are also stored when accumulating a fragment. Fragmentation data are changed into the data suitable for the are recording medium of the contents are recording section 329 in order to take out the specific fragment accumulated in the contents are recording section 329, since fragmentation data are the information for receiving the fragment broadcast (step S30).

[0095] Thus, the accumulated fragment is dealt with as data equivalent to the received fragment, as a broken-line path shows. Although omitted, the corresponding fragment is searched with the contents are recording section 329, and the detail can perform control received from a broadcast signal, when there is no corresponding fragment.

[0096] A ***** user can change the fragment displayed on a child screen to the notice made in step S27. If a notice is instead made, you may make it set up beforehand so that the fragment displayed on a child screen may be changed automatically.

[0097] In step S28, if not accumulating the received fragment is determined, it will be determined in step S31 whether display the fragment immediately. Processing will be completed if not displaying immediately is determined. If displaying immediately is determined, contents playback / are recording control section 333 will generate a display window (child screen) in the suitable location on a screen (step S32). A fragment is displayed on this display window (step S33). A

display window will be eliminated if a display is completed (step S34). And processing is completed.

[0098] Processing shown in the flow chart of drawing 24 can be realized with software. This software is stored in CD-ROM, and is sold or distributed to each viewer. Not only CD-ROM but the Internet and broadcast can be led, and software can be sold or distributed.

[0099] Drawing 25 shows the example of a screen display. First, the presentation control application beforehand installed with the accepting station is started. The screen display shown in drawing 25 A is made by it. In drawing 25, 501 shows a graphic display screen, 502 shows a display application icon, and 503 shows the list display of an event during advance. The event icon showing an event is shown in the list display 503. The event icon shown is set up as a user profile. In drawing 25, although the event icon is shown by the geometric figure, the pattern which can be immediately reminded of an event is desirable. The arrow head for scrolling for changing an event is displayed on list display a top and the bottom.

[0100] In the condition of drawing 25 A, if the metadata of a certain event in two or more events currently displayed on the list display 503 is received or it will be in the condition which can show the fragment relevant to the metadata, as shown in drawing 25 B, it would be received in the list display 503, or the event icon whose presentation was attained will change to highlighting. A viewer understands that presentation of the event of highlighting is possible. By plural junction, the display of two or more events may be attained. It is shown by drawing 25 B within the list display 503 that presentation of three events is possible. Inverse video may be performed in addition to highlighting, or you may make it make an icon blink.

[0101] When a user operates a playback/are recording control unit 347 like a remote controller, one in the event icon by which highlighting is carried out is chosen. Completion of selection indicates the selected event icon other things and a distinguishable thing. For example, inverse video is carried out. As the image of the fragment of the selected event shows drawing 25 C, it is displayed on the child screen 504.

[0102] Moreover, as shown in drawing 25 D, it replaces with a user operating playback/are recording control unit 347, and the image of the fragment corresponding to the event icon of highlighting can be automatically displayed on the child screen 504. That is, the child screen 504 is generated by becoming highlighting and coincidence, and the image of the fragment of the event corresponding to the icon of highlighting is displayed there. Two or more events are displayed on the child screen 504 in order.

[0103] In addition, he is trying to display the image of the game received or accumulated in the event corresponding to the set-up user profile in drawing 25. You may make it metadata display the detailed information about the game described by metadata on a child screen instead of displaying the image of an actual game, since detailed description about a game can be performed.

[0104] In addition, this invention can be applied not only sport relay broadcast but when displaying a news program etc. on a child screen. Moreover, the picture and picture which divide a screen and display other programs may be adopted as means of displaying. Furthermore, when not the thing restricted to 2 screen-display methods but the fragment corresponding to user profile information is received, it is also possible to transpose the screen till then to the screen of the fragment. Although the image displayed on a parent screen or one screen may display playback images, such as not only a program but VTR, a disk regenerative apparatus, etc., more nearly further, the image displayed on a child screen etc. is a program. As broadcast, it is digital broadcast of digital satellite (CS, BS, data) broadcast, digital terrestrial broadcasting, etc.

[0105]

[Effect of the Invention] In this invention, if metadata is given for every fragment of a program and the fragment of the metadata corresponding to user profile information is broadcast by other channels, automatically, it can replace with the screen till then, or the image of that fragment can be displayed on a child screen (other screens). Therefore, a user does not need to change a display, and the child screen etc. is shown, and a user does not have to do the monitor of the screen and can improve operability.

[0106] Moreover, in this invention, since a user is notified of having received the fragment of the

metadata corresponding to user profile information, the image of that fragment can be displayed by a user's selection.

[0107] Furthermore, in this invention, it becomes possible to display the detailed information described by the metadata not only corresponding to the fragment of contents but a user profile.

[Translation done.]

* NOTICES *

JPO and NCIP are not responsible for any damages caused by the use of this translation.

- 1.This document has been translated by computer. So the translation may not reflect the original precisely.
- 2.*** shows the word which can not be translated.
- 3.In the drawings, any words are not translated.

DRAWINGS

[Drawing 4]

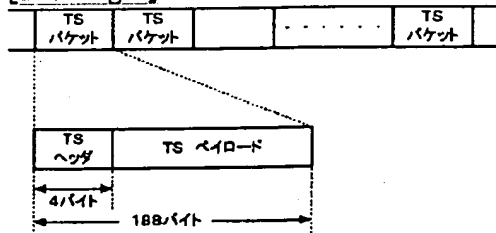

[Drawing 6]

```

<Service id="Svc01">
  <Event id="E#5" start_time=20:00 duration=02:00>
    <Segment id="S#1" start_time=20:00 duration=00:20/>
    <Segment id="S#2" start_time=20:20 duration=01:20/>
    <Segment id="S#3" start_time=21:40 duration=00:20/>
    <Segment id="S#4" start_time=20:30 duration=00:20/>
    <Segment id="S#5" start_time=21:00 duration=00:30/>
  </Event>
</Service>
    
```

[Drawing 9]

```

<Segment ID="S#3">
  <News:Category ID="Politics"/>
  <News:Area ID="Domestic"/>
</Segment>
<Segment ID="S#5">
  <News:Category ID="Sports"/>
  <News:Area ID="international"/>
</Segment>
    
```

[Drawing 1]

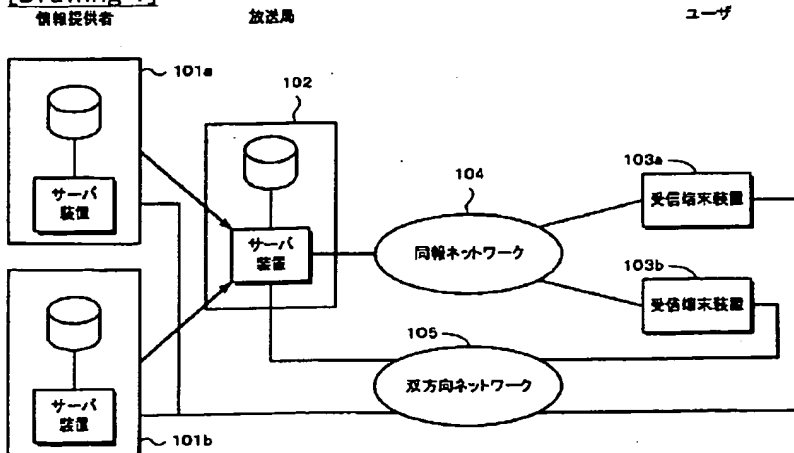

[Drawing 2]

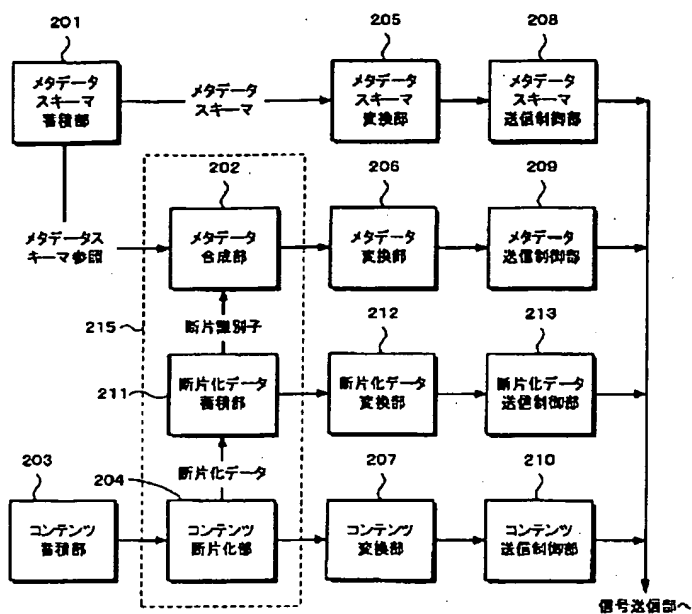

[Drawing 5]

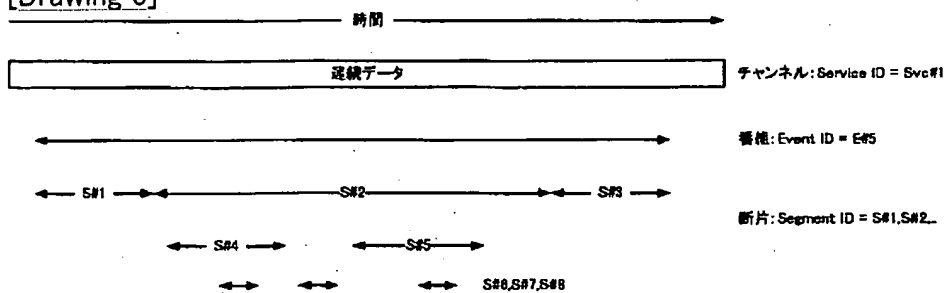

[Drawing 7]

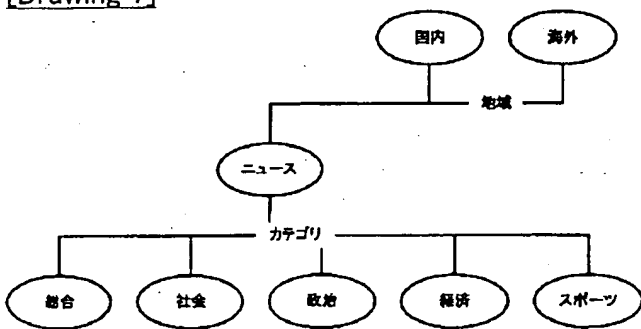

[Drawing 8]

```

<Segment ID="S#3" start_time=xx:xx duration=xx:xx/>
..
<Segment ID="S#5" start_time=xx:xx duration=xx:xx/>
..
    
```

[Drawing 13]

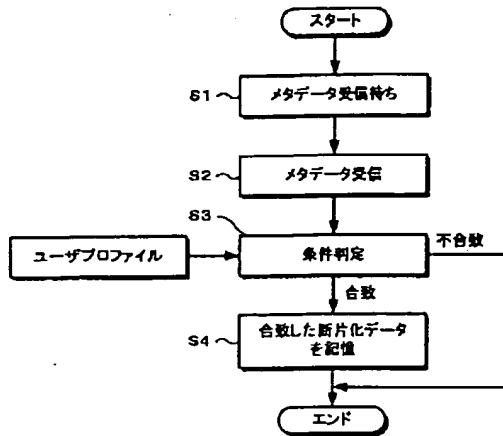

[Drawing 3]

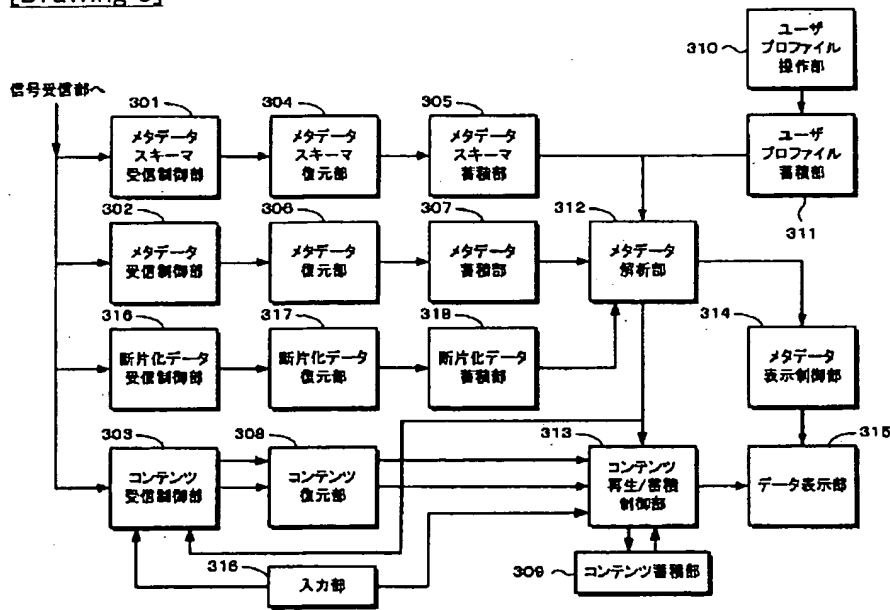

[Drawing 10]

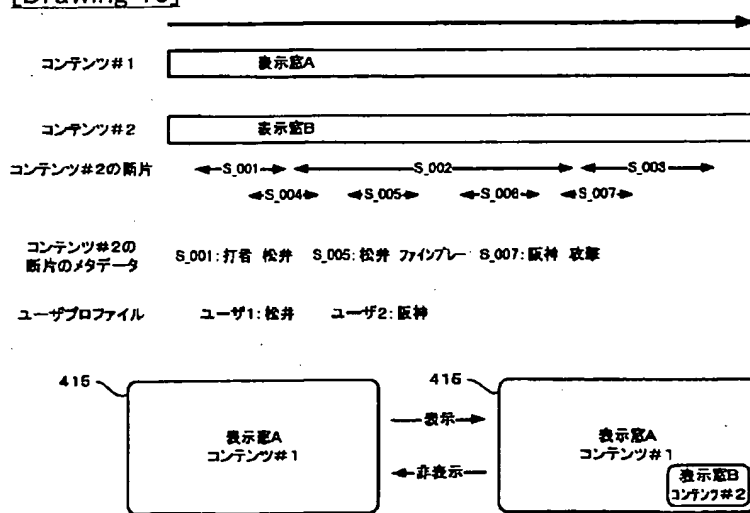

[Drawing 12]

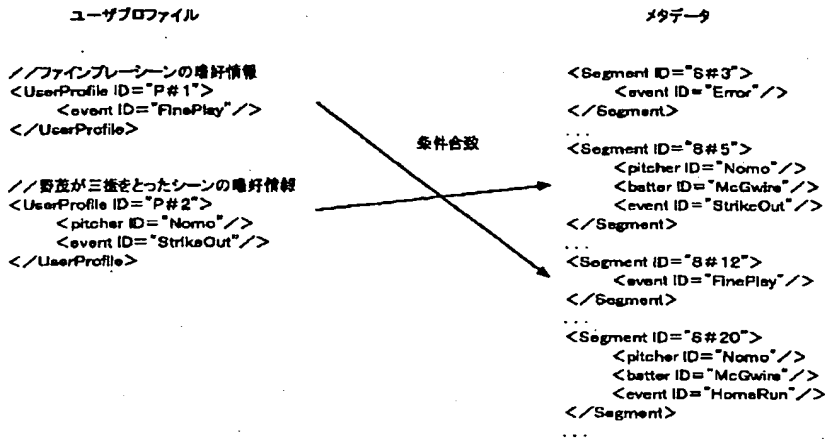

[Drawing 14]

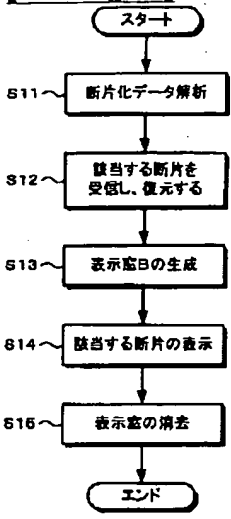

[Drawing 18]

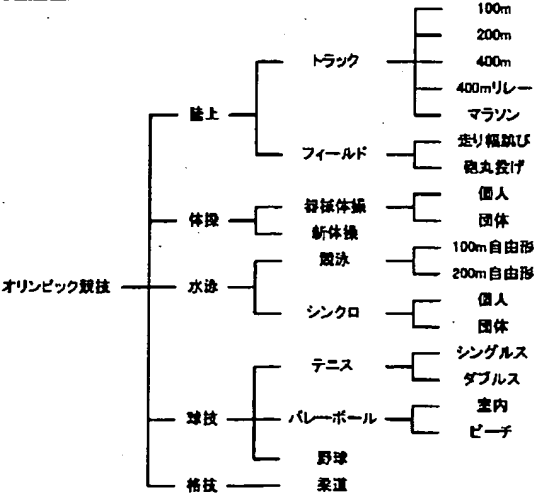

[Drawing 23]

```
//断片S#3の情報
<Segment ID="S#3"> //断片識別子=S#3
  //サービスID=Svc#1、10時から12時まで
  <service IDREF="Svc#1"/>
  <start_time>10:00:00</start_time>
  <end_time>12:00:00</end_time>
</Segment>
...
//断片S#5の情報
<Segment ID="S#5"> //断片識別子=S#5
  //サービスID=Svc#3、11時半から12時まで
  <service IDREF="Svc#3"/>
  <start_time>11:30:00</start_time>
  <end_time>12:30:00</end_time>
</Segment>
...
```

[Drawing 11]

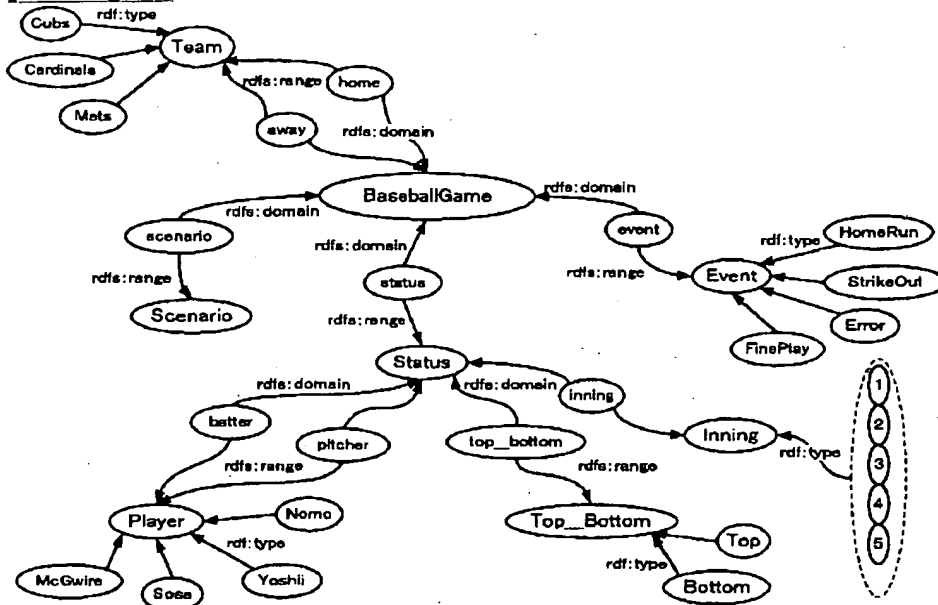

[Drawing 15]

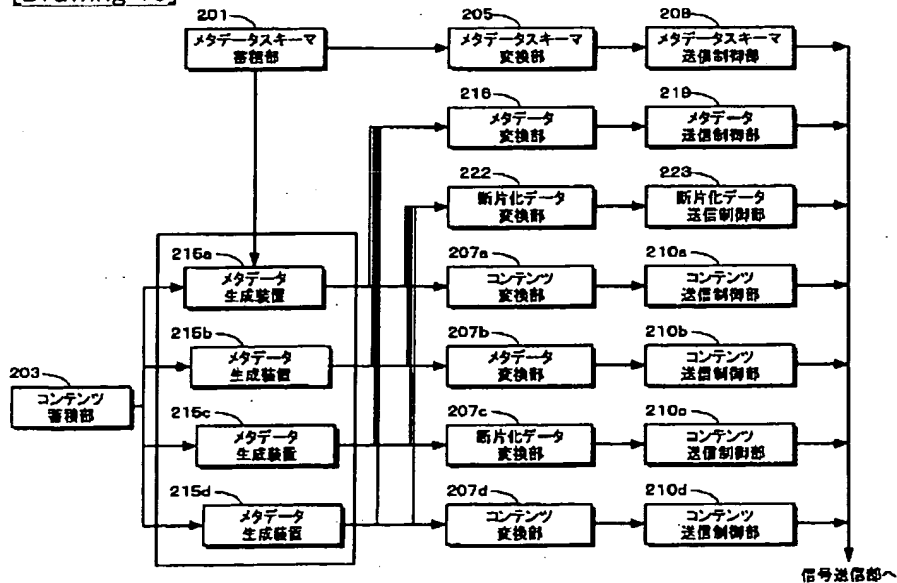

[Drawing 21]

```
//マラソンの嗜好情報
<UserProfile ID="P#1">
  <category IDREF="Athletics">
    <category IDREF="Track">
      <category IDREF="Marathon"/>
    </category>
  </category>
</UserProfile>
```

```
//新体操の嗜好情報
<UserProfile ID="P#2">
  <category IDREF="Gymnastics">
    <category IDREF="Rhythmic"/>
  </category>
</UserProfile>
```

```
//テニスシングルの嗜好情報
<UserProfile ID="P#3">
  <category IDREF="BallGames">
    <category IDREF="Tennis">
      <category IDREF="Singles"/>
    </category>
  </category>
</UserProfile>
```

```
//格技の嗜好情報
<UserProfile ID="P#4">
  <category IDREF="MartialArts"/>
</UserProfile>
```

[Drawing 22]

```
//断片S#4に関するメタデータの記述
<Segment IDREF="S#4">
  //マラソン番組のメタデータ
  <category IDREF="Athletics">
    <category IDREF="Track">
      <category IDREF="Marathon"/>
    </category>
  </category>
</Segment>
```

```
...
//断片S#9に関するメタデータの記述
<Segment IDREF="S#9">
  //バレーボール番組のメタデータ
  <category IDREF="BallGames">
    <category IDREF="VolleyBall"/>
  </category>
</Segment>
```

```
...
//断片S#13に関するメタデータの記述
<Segment IDREF="S#13">
  //柔道番組のメタデータ
  <category IDREF="MartialArts">
    <category IDREF="Judo"/>
  </category>
</Segment>
```

[Drawing 26]

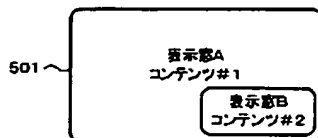

[Drawing 16]

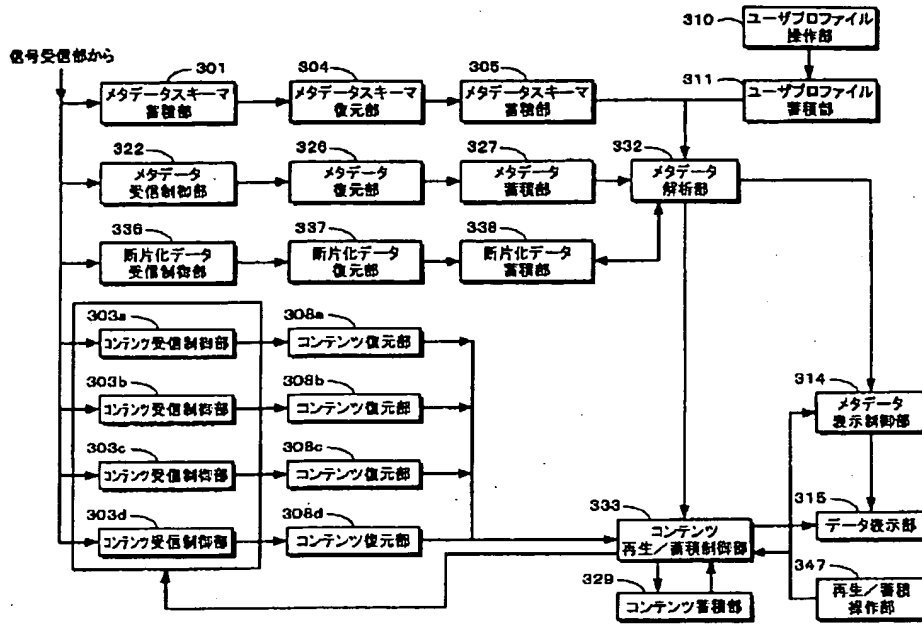

[Drawing 17]

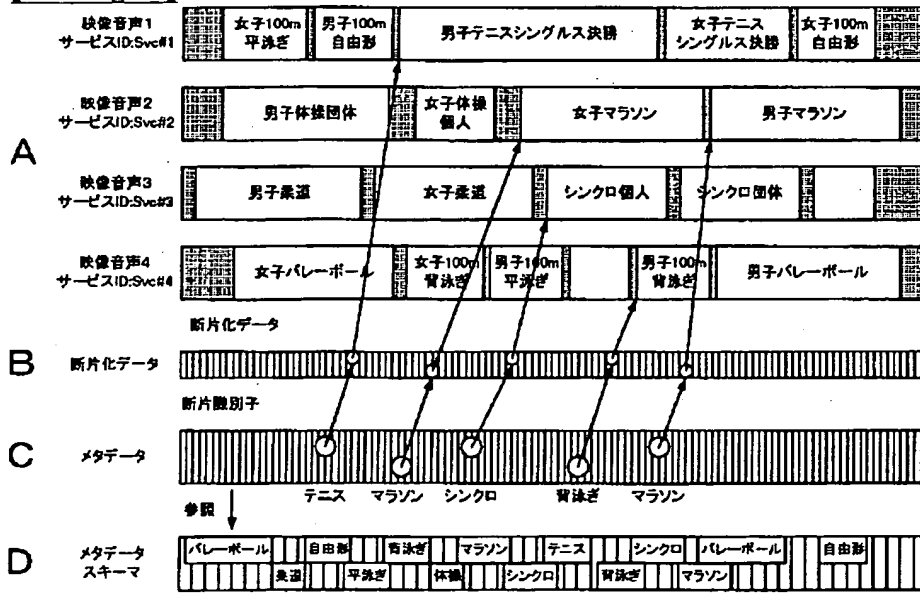

[Drawing 19]

//オリンピック競技用メタデータスキーマ

<OlympicSchema>

```

<category ID="Athletics">
  <category ID="track">
    <category ID="100m"/>
    <category ID="200m"/>
    <category ID="400m"/>
    <category ID="400mRelay"/>
    <category ID="marathon"/>
    ...
  </category>
  ...
</category>
<category ID="Fields">
  <category ID="RunningLongJump"/>
  <category ID="ShortPut"/>
  ...
</category>
<category ID="Gymnastics"/>
  <category ID="Apparatus"/>
  <category ID="Rhythmic"/>
</category>
  ...

```

<OlympicSchema>

[Drawing 20]

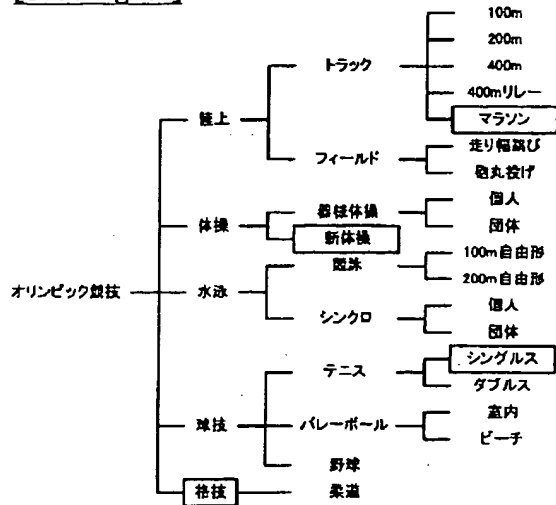

[Drawing 24]

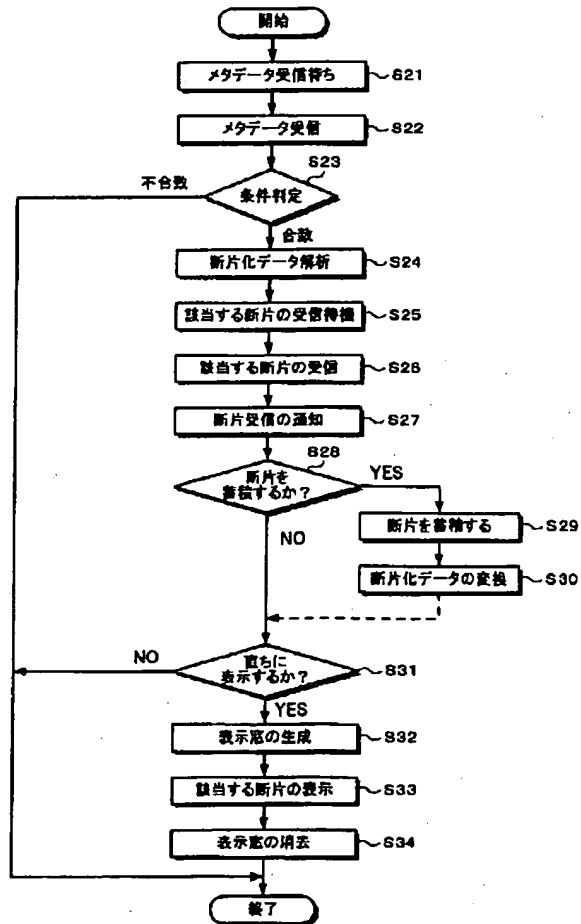

[Drawing 25]

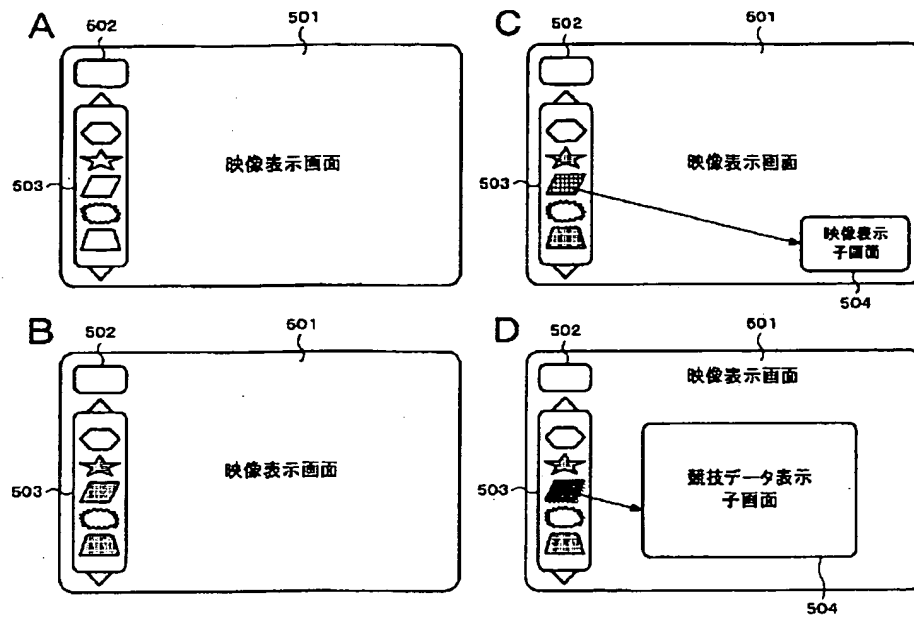

[Translation done.]

**This Page is Inserted by IFW Indexing and Scanning
Operations and is not part of the Official Record**

BEST AVAILABLE IMAGES

Defective images within this document are accurate representations of the original documents submitted by the applicant.

Defects in the images include but are not limited to the items checked:

BLACK BORDERS

IMAGE CUT OFF AT TOP, BOTTOM OR SIDES

FADED TEXT OR DRAWING

BLURRED OR ILLEGIBLE TEXT OR DRAWING

SKEWED/SLANTED IMAGES

COLOR OR BLACK AND WHITE PHOTOGRAPHS

GRAY SCALE DOCUMENTS

LINES OR MARKS ON ORIGINAL DOCUMENT

REFERENCE(S) OR EXHIBIT(S) SUBMITTED ARE POOR QUALITY

OTHER: _____

IMAGES ARE BEST AVAILABLE COPY.

As rescanning these documents will not correct the image problems checked, please do not report these problems to the IFW Image Problem Mailbox.